

530Ø

KUPOLA

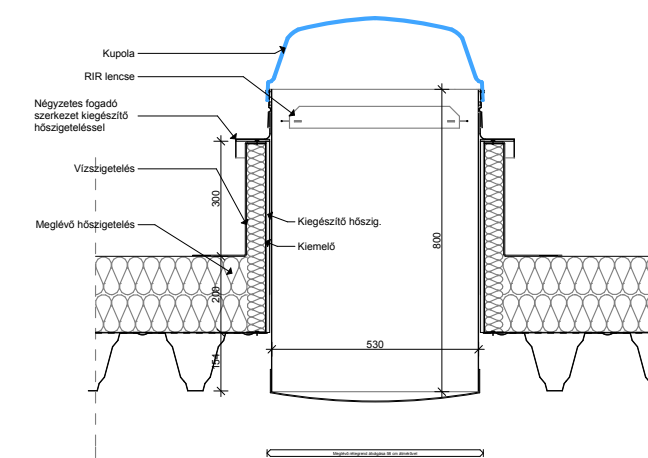
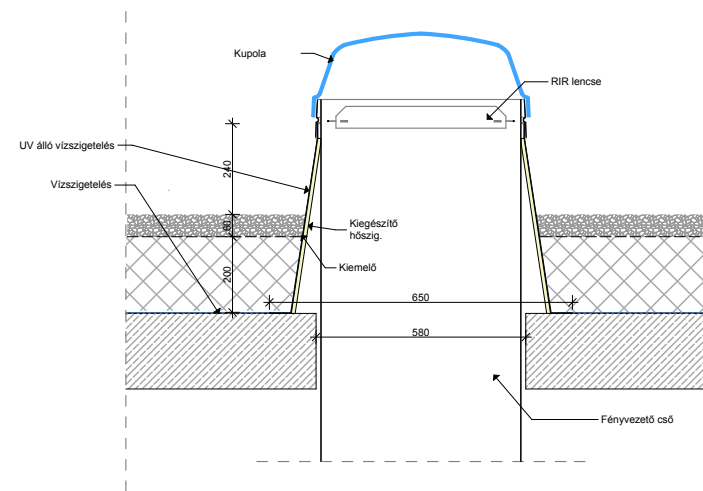
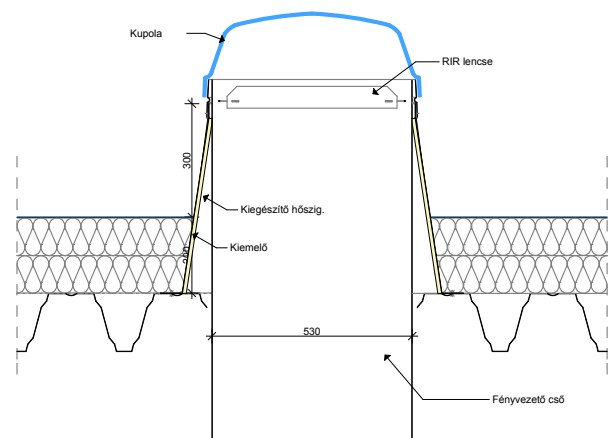
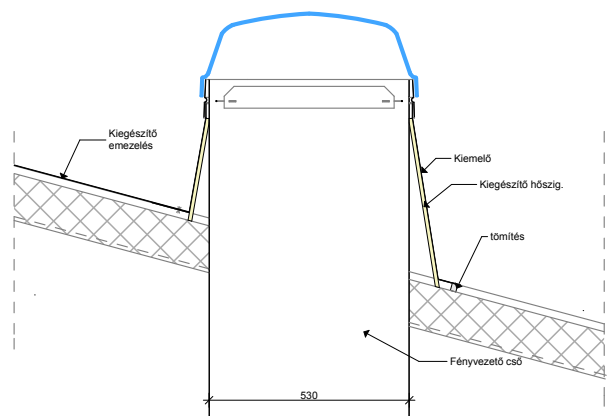

KIEMELŐ

vált.

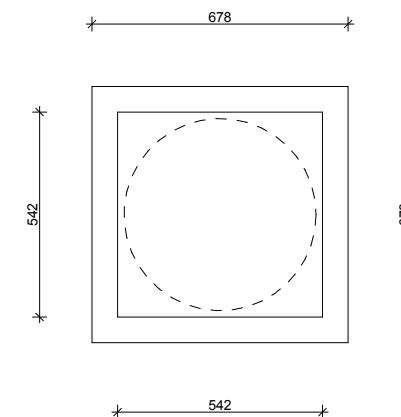
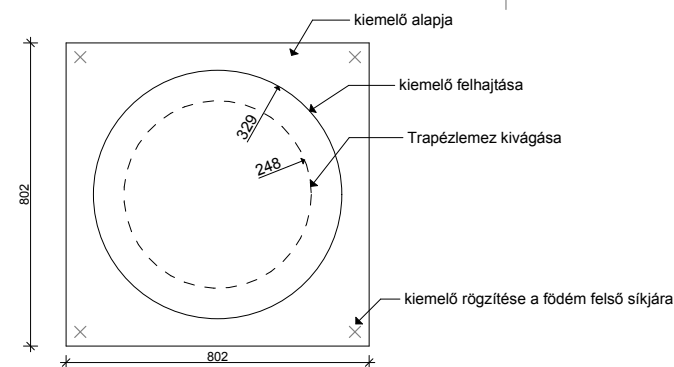
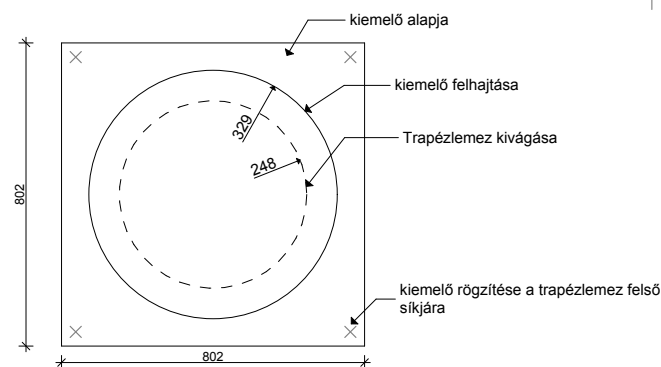

FÉNYSZÓRÓ

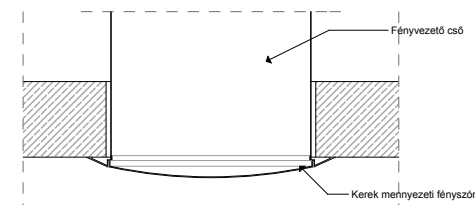
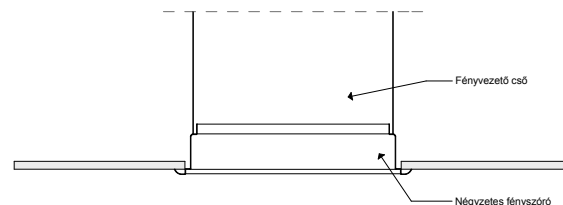
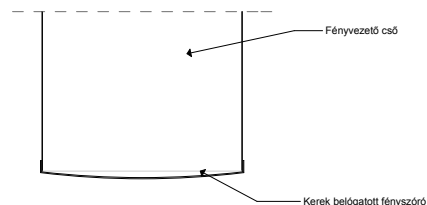

Statikai kiváltás szükségessége minden esetben egyedileg vizsgálandó